

MARKING
CL-A35M-L170-d15-S1

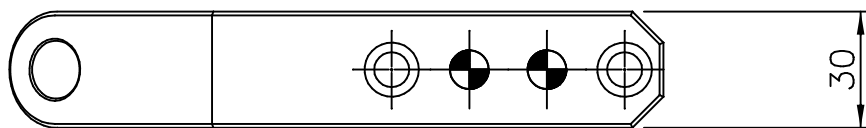
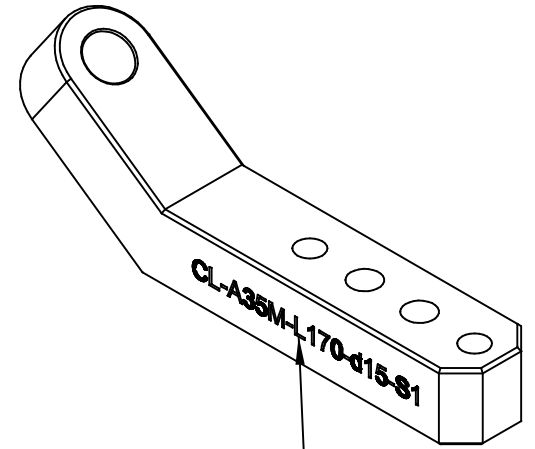

SCALE	NAME	Q'TY
1 / 1	LINK	1EA
MODEL	DWG.NO	
	CL-A35M-L170-d15-S1	