

MARKING
CL-A00-L175-d15-S1

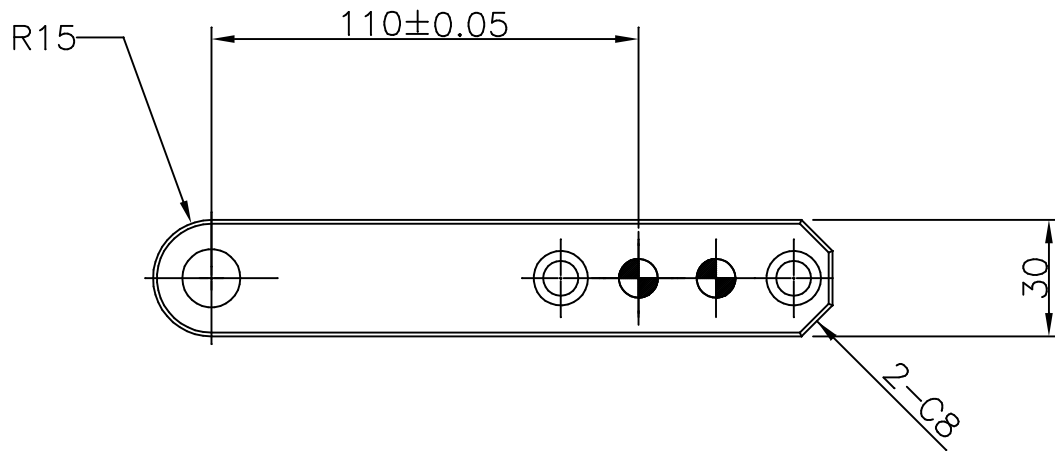

SCALE	NAME	Q'TY
1 / 1	LINK	1EA
MODEL	DWG.NO	
	CL-A00-L175-d15-S1	